

This and additional supporting material may be found at <https://github.com/openhamclock/hamclock/tree/main/doc>

HamClock is a kiosk-style application that provides real time space weather, radio propagation models, operating events and other information particularly useful to the radio amateur. When started, you may enter the Setup system. Setup is required if key entries are missing or invalid.

Setup provides several pages of configuration options. The exact choices available will depend on your platform but all options are shown below for completeness. **Orange** text denotes passive prompts for the corresponding **White** entry fields to their right. **Cyan** text denotes on/off choices or other discrete options. Clicking on a data entry field will place a green cursor where the next character will go. Click **Delete** to erase the character to the left. Click the **Page** arrows to move to next or previous. When finished, click **Done**. If any fields do not pass checks, they are marked with a red **Err** and you remain on the Setup screen until corrected.

Pages with text fields include a virtual keyboard for use on touch screens or with a mouse. On desktop systems, a normal keyboard may also be used using *tab* to step to the next prompt; *delete* to erase a character, *space* to toggle discrete options; *arrow* keys to edit; *escape* to change page and *Return* for Done.

Many places have popup tool tips activated with either control-click or middle mouse button.

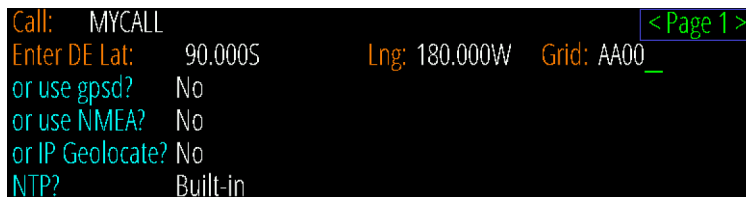

**Call:** enter your call sign, up to 11 characters; at least 1 digit; length at least 3; no punctuation except /

The remaining fields allow setting *location* manually with lat/long or grid, or automatically with gpsd, NMEA sentences or IP Geolocation; and *time* from gpsd, NMEA, NTP or the computer. The fields automatically prevent selecting conflicting resources.

**DE Lat, Long, Grid:** these fields manually set the DE location. You may enter a maidenhead grid or enter latitude and longitude with optional  $\pm$  degrees or N/S suffix with Lat and E/W with Lng.

**use gpsd?** Allows connecting to a gpsd daemon on your local network for. Enter the host name of your gpsd server; the port is fixed to 2947.

**use NMEA?** Allows reading NMEA sentences directly from a GPS device; see page 25.

Both gpsd and NMEA normally only set the time but selecting **follow** will also update the DE location occasionally, handy if HamClock is in an RV for example.

**IP Geolocate?** If Yes, uses your public IP to set DE location once. This may not be accurate.

**NTP?** *Built-in* will use the best from among a default set of world-wide NTP servers; *host* allows entering the IP or host address of any desired NTP server on the network; *Computer* uses the time from the computer running HamClock (ok, not NTP but here for convenience).

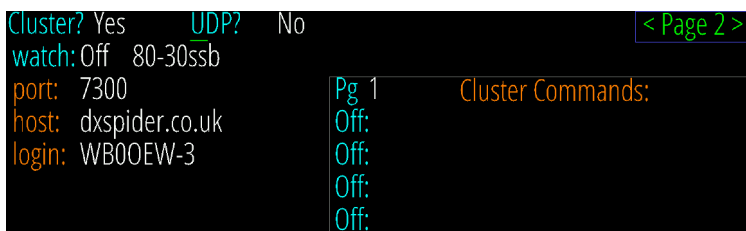

**Cluster?** This section configures listening to an internet DX Cluster or a local program sending spots with UDP packets. See page 9 for additional information.

**watch:** see page 20.

**Cluster Commands** can be entered in the table. Those marked **On** will be sent once to the cluster server right after logging in. These must be in the native cluster syntax, *HamClock does not check them*. Commands marked **Off** are saved but not sent. Click **Pg** to cycle through more entry lines.

```
rotctld? No port: 4533 host:localhost < Page 3 >
rigctld? No port: 4532 host:192.168.7.110
flrig? Yes port: 12345 host:192.168.7.110
Radio: Monitor
ADIF? file: ~/Desktop/log.adif
ADIF watch: Off VKXE
ONTA watch: Off J
```

**rotctld? rigctld?** Whether and how to connect to **hamlib** for rotator and/or radio control. See pages 12 and 14.

**flrig?** Whether and how to connect to W1HKJ's **flrig** for rig control. See page 14.

**Radio:** if using either rig connection, choose whether to set spot frequencies or just monitor PTT.

**ADIF?** Set file used by the ADIF pane; may include environment variables and ~. See page 13.

**ADIF and ONTA watch:** see page 20.

```
Map center lng: 90W < Page 4 >
GPIO? Active I2C file? name: /dev/cu.usbserial-DK0C3XGZ
BME280@76 dTemp: 0.00 dPres: 0.000
BME280@77 dTemp: 0.00 dPres: 0.000
KX3? 4800 bps
Brightness Min%: 0 Max%: 100
```

**Map center lng:** set desired center map longitude for the Mercator and Robinson projections.

**GPIO?** Controls whether the native RPi GPIO pins will be used by HamClock. See page 24.

**I2C file?** name of the local I2C bus connection, either native or via USB. See page 24.

**dTemp, dPres:** temperature and pressure corrections added to each BME280 sensor. See page 22.

**KX3?** Toggle direct KX3 frequency control and set serial baud rate. RPi only; see page 22.

**Bright Min% and Max%:** display brightness range, if supported, as percent of hardware total.

Date order?	Mon Day Year	Log usage?	Opt-In
Week starts?	Sunday	Demo mode?	No
Units?	Metric	Bearings?	True N
Show public IP?	No	New DE/DX Wx?	Yes
Spot labels?	Prefix	Min label dist?	2000
Scroll direction?	Bottom-Up	Gray display?	No
Pane rotation?	30 seconds	Map rotation?	20 seconds
Show UDP spots?	By me	Look up bio?	No
Auto SpcWx map?	No	UDP sets DX?	No
Full scrn web?	No	Auto upgrade?	03:00
Full scrn direct?	No	Max TLE age:	7 days

**Date order?** choose one of three formats for all date displays.

**Log usage?** choose whether to send us your HamClock settings *anonymously* to guide further development.

**Week starts?** choose whether the first calendar column is *Sunday* or *Monday*.

**Demo mode?** *Yes* causes HamClock to change its own settings automatically. See page 19.

**Units?** choose *Metric*, *Imperial* or *British* units for environment sensor, weather data, speed and distances.

**Bearings?** choose *True* or *Magnetic North* when displaying bearings to DX.

**Show public IP?** whether the main page shows the public network address (local address is always shown)

**New DE/DX Wx?** whether to temporarily show weather in left Pane when setting new DX or DE.

**Spot labels?** select whether and how to label Live Spots, On The Air and DX Cluster map locations.

**Min label dist?** select minimum distance from DE to label spots; distance in mi or km depending on Units

**Scroll direction?** whether scrolling panes fill from *bottom-up* or *top-down*.

**Gray display?** whether to render map or entire display in shades of gray

**Pane rotation?** select one of several pane rotation periods.

**Map rotation?** select one of several map rotation periods.

**Show UDP spots?** select whether to accept all incoming UDP spots or just those by your HamClock call

**Look up bio?** select which online bio service to use when clicking a spot, if any

**Auto SpcWx map?** turn on Aurora map if > 50% or DRAP if > 25 MHz; off if < 25% or < 15 MHz, with hysteresis.

**UDP sets DX?** when *Yes* spots from any supported UDP logging program will automatically set the DX object.

**Full scrn web?** set to *Yes* to enable full screen option on Live web connections.

**Auto upgrade?** select whether or about when (DE timezone) to automatically upgrade if new version is available

**Full scrn direct?** set to *Yes* to force HamClock to fill all surrounding screen area with black, when applicable.

**Max TLE age:** select maximum allowed satellite Keplerian two-line element age, in days

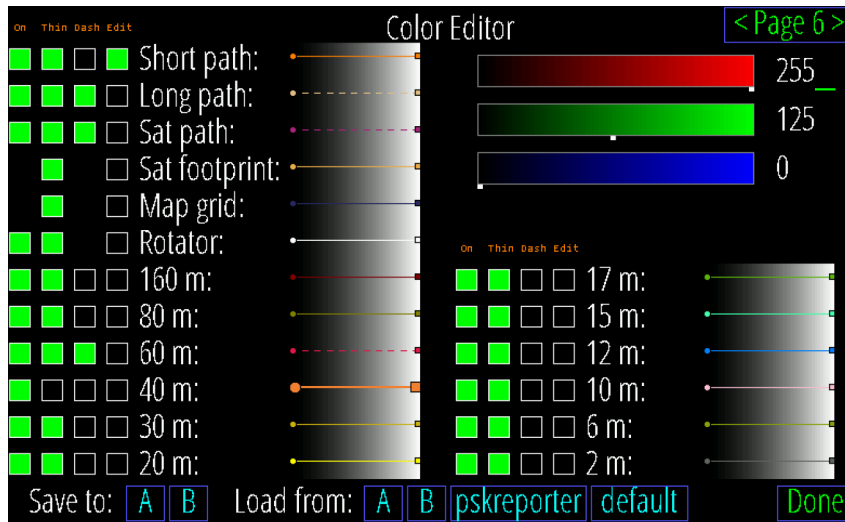

**Color Editor:** This page displays and controls the colors used for map paths and band indications. Click one of the *Edit* buttons to display its RGB color definition in the edit box in the upper right. The box works by clicking within a color bar or clicking a numeric value which can then be edited with the keyboard. Click *Dash* to toggle whether map paths are drawn dashed or solid; *Thin* to set line and symbol size; and *On* to set whether the path is drawn on the map (it always remains editable here). A sample of each color shows how the current choices will appear over a full range of background intensities. The current palette and choices may be saved as A or B then later these, or two read-only built-in palettes, may be loaded.

DE Daily Display On/Off Times							
	< Sun >	< Mon >	< Tue >	< Wed >	< Thu >	< Fri >	< Sat >
On	08:00	06:00	06:00	06:00	06:00	06:00	08:00
Off	22:00	23:00	23:00	23:00	23:00	23:00	22:00

**On/Off Times:** Use this table to set desired DE on and off (or dim) times for each week day. Click just above or below each number to increase or decrease. Left and Right arrows copy to the adjacent day. The On/Off pane will also display, and allowed editing, the current day settings (only) (see page 8 ). The display is never turned off if both times are set equal. Not available on all systems.

- Click to cycle background color
- Click to set message, see page 14
- Click to cycle text color

Up time; Local IP; Public IP; disk usage; WiFi signal; CPU temp; Backend server IP and host. red if trouble; click might show more

Click to shift time forward or back

Click to change time units

Click for Stopwatch, count down timer and Big Clock

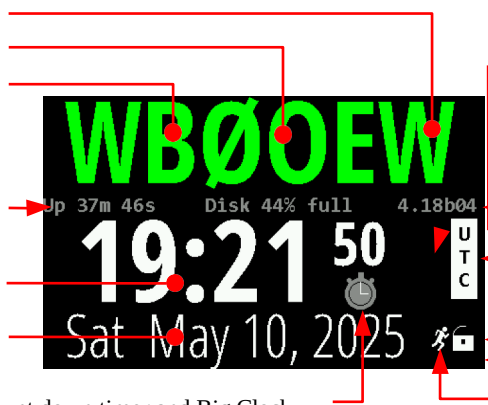

Big ? here if time is not syncing

Current version. Red when old. Click to update.

Red OFF if not UTC, click to reset

Click to set lock, demo (page 19), manage configurations, exit, restart, or send diagnostics

Number of live web connections and whether Read-Only or R-Write

Indicates demo mode (page 19)

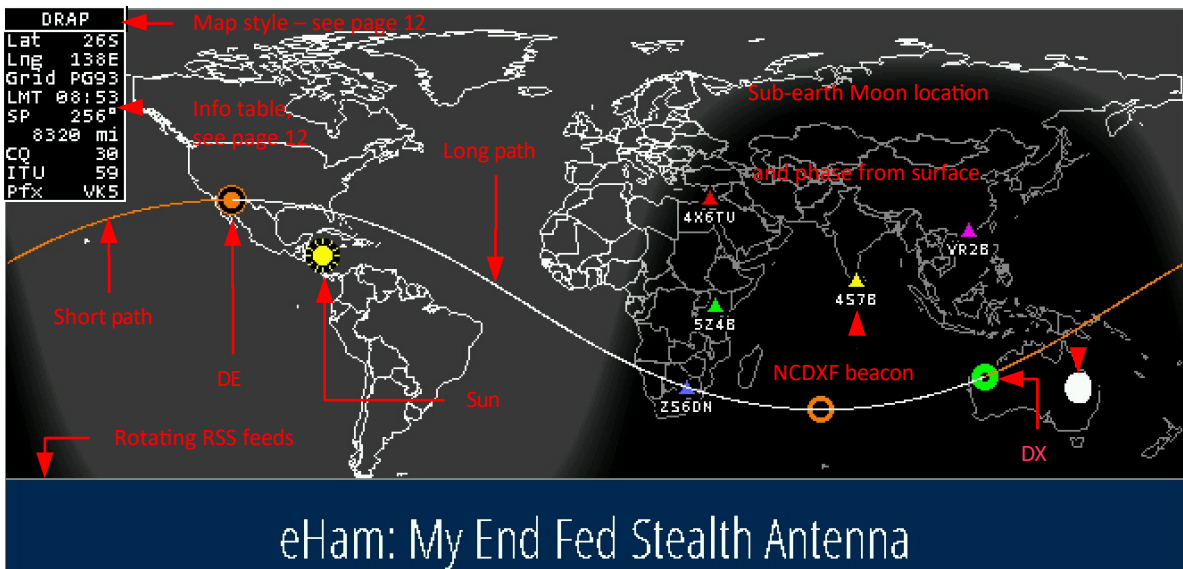

Mercator projection centered at 0° longitude -- click anywhere to set DE, DX, pan or zoom, see page 14

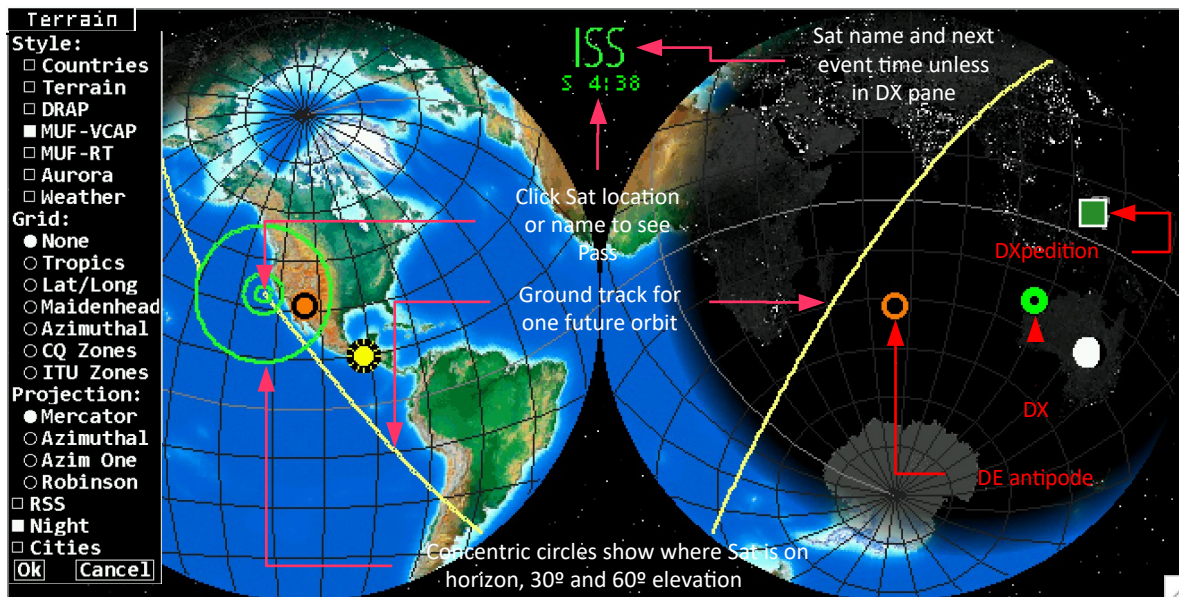

Azimuthal projection centered on DE



The **DE** panel shows HamClock's idea of your location and local time. HamClock uses this location for many purposes from lunar angles to spot bearings. In this default format the panel shows local time and date, latitude and longitude, grid square and sun rise and set events. Click **DE**: to select other formats or select **Data Panes** (listed starting on page 9) that can overlay this and the DX panel. Click location to edit lat, long or grid, see page 14. Click **R** or **S** to toggle showing the time **at** which the next or previous events occur, or the interval **in** which they will or have occurred. Click the timezone offset to update if necessary; see page 16 for more about how HamClock manages time.

click to set format

click to manage DE time zone, see page 19

click to select at/in

click to set DE location, see page 14



The **DX** panel shows HamClock's definition of a second location independent from DE. Controls and layout are similar to the DE panel except the rise/set table also has an option to show the DX location prefix; clicking DE shows a list of satellites that can be tracked; and clicking **LP** or **SP** toggles whether the data shown refers to long path or short path. If a satellite has been selected, this panel changes to display its next pass; see next.

click to manage DX time zone, see page 19

click to choose up to two satellites

click to toggle short or long path

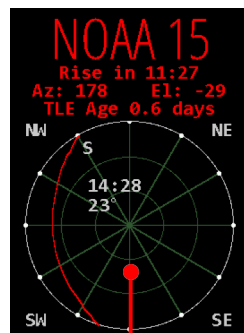

The **DX** panel can be repurposed to show details of the next satellite pass as viewed from DE. Below the satellite name is the time until the next Rise or Set event, current az and el, and TLE age. Rise and set are based on the satellite passing above or below the ideal geometric horizon without regard to refraction. The time format will be **HHhMM** if the event is more than an hour away otherwise **MM:SS**. A schematic representation shows how the pass will appear in the sky above DE oriented as shown by the compass directions in each corner. Faint lines are drawn at 30° and 60° elevation and every 30° in azimuth. The setting end of the pass is marked with an **S**. Midway along the pass are shown the **duration** as MM:SS and **maximum elevation** in degrees. Click anywhere in the circle for a menu of additional options.

click for more options

- Below are descriptions of the tall narrow pane in the upper right corner of HamClock.
- Click near the top for a menu of available choices; choose one, or more will cycle; ctrl-click to rotate.
- Some choices also use lower click positions for specific functions as described below.

### Display Brightness Control (see page 16)

Optional light sensor reading

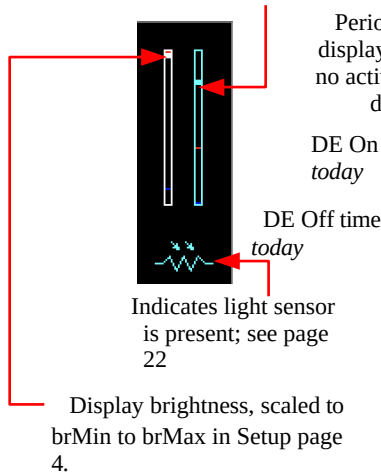

### Display On/Off Timer (see page 16)

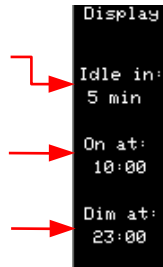

Times are reset from table in Setup page 7 each midnight

### NCDXF Beacons



Map color key  
Frequency, MHz

### BME Env stats



Click value to set Pane

### Space Wx stats ranked by impact if Auto



Click value to set Pane, or name to choose, or Auto

### DE/DX Wx stats



Click to choose

### NCDXF Lightning panel



This panel shows an aged list of lightning strikes. Click on the 2<sup>nd</sup> number to change radius to/from worldwide or km (max 10000)

## Data panes

- Click the top center of a pane for a menu of choices; more than one will cycle; ctrl-click to force rotation.
- Choices may be assigned to one pane at a time, and most panes must be assigned at least one choice.
- Some choices also use lower click positions for specific functions as described below.

click to clear list

Frequency	Call	Age
28460.0	HJ3ESF	11m
3517.0	RU5D/M	10m
3574.7	HA8LD	10m
14252.0	PP5KJ	9m
28450.0	8A1001ARU	7m
18100.0	EA7FPC/MM	6m
18100.7	V31DL	2m

\* **DX Cluster** lists and maps spots from the cluster host defined in Setup page 2, subject to age, any filters and watch list (see page 20). See page 10 for setup info and 13 for scroll controls. Frequencies are colored by band as per Setup page 6. Only the latest spot of a given call on the same frequency is shown. The columns are kHz, call and age. Click any row to set DX, rotator (page 12), radio (page 14) and look up bio if configured. Click the host name to edit the watch list. Roaming over a list entry will mark it on the map. Clear the list by clicking CLR. The list will not move if scrolled away but arrival of a spot will display NEW.

click to set whether to show bio (if configured), set max age and edit watch list click

spot to set DX, radio and bio if enabled; roam over to mark on map

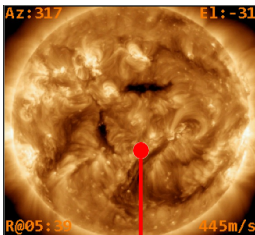

**SDO** shows current images from the Solar Dynamics Observatory satellite. The corners show current information with respect to an observer located at DE including the Azimuth, Elevation, time of next Rise or Set, and radial velocity where positive values indicate the motion is away from the observer. Click near the center of the image to display a menu allowing any one of several image types to be selected; select **Rotate** to automatically cycle them all in turn; show a **Grayline** planning tool where DE and DX share twilight whenever either of their rise/set lines are close together; or display a recent solar **Movie** in a separate browser window.

click for menu

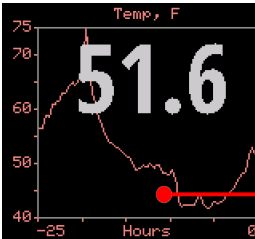

If an optional **BME280** environmental sensor is installed and working (see page 16), then several pane options are available whose names begin with **ENV** to display temperature, humidity, dew point or station pressure. The current value is shown along with a 24 hour history. Clicking near the bottom of the pane will cycle immediately to another ENV choice without having to use the normal menu. If two sensors are installed, the pane is split to show graphs from each, labeled with their respective I2C bus addresses.

click to cycle to next ENV pane

Location	Call
Guyana	8R1TM
Br Virgin Is	VP2VI
St Helena	ZD7PG
Guadeloupe	FG
Bermuda	VP9KF
Palau	T88UM
Kenya	5Z4FV
Dominica Island	J79WTA

red if marking spots but no DX Cluster connection or green if ok

click to show date, only current, hidden; mark DX Cluster spots in red; or open provider's web page.

\* **DX Peditions** lists current, or upcoming, amateur DX expeditions. Click the credits line for overall menu options. Click a specific contest to hide; set a future alarm; assign to DX; or display the expedition web page, if any. Roaming over a list entry will mark it on the map. Map info table will show spotted frequency and, if ADIF is configured, worked slots to same DXCC. Data are kindly provided by DXNews and G3K.

red if spotted

click an expedition to hide; set future alarm; assign to DX, or open web page; roam over to mark on map

Contest Name	Time
WA7BNM Weekend Contests	
AGCW Straight Key Party	Sat 16:00 - Sun 19:00Z
British Columbia QSO Party	Sat 16:00 - Sun 23:59Z
North American Sprint, CW	Sun 00:00 - 03:59Z
Marconi Club ARI Loano	Sun 13:00 - 23:00Z

click to select whether to show date and timezone

\* **Contests** lists amateur radio contests for the upcoming, or current, weekend. Click the credits line to set whether to show dates in UTC or DE time zone. Click a specific contest to set the one-time future alarm to the contest start time or display the WA7BNM web page for the contest. Contests currently in progress are highlighted with a green background. Data are kindly provided with permission by Bruce Horn, WA7BNM.

click a contest to set alarm or open contest on WA7BNM web page

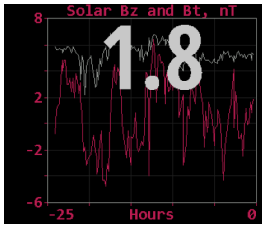

**Bz Bt** shows the strength of the interplanetary magnetic field near Earth in units of nano Tesla.  $B_z$  is the strength of the field pointing north, the same direction as the Earth's field.  $B_t$  is the total vector sum in all directions, and thus is always the larger value. When  $B_z$  is negative, the fields are in opposite directions, partially cancelling the net shielding effect of the magnetosphere and negatively impacting HF propagation. Values of  $B_z < -10$  can be significant.

**On The Air** ▼55

POTA

14270	KE5AKL	US-11791
14267	K3MTO	US-1884
7043	VA2EO	CA-4959
7238	N2MJK	US-4365
14058	KE9BHN	US-0986
14315	K5DC	US-1778
14305	K2WPA	US-0561

\* **On The Air** shows spots from various organizations. Current orgs are POTA, SOTA and WWFF; more may be added. The current org is shown below the title. The table columns are kHz, activator call and code, and **m** if > 10 minutes or **h** if > 1 hour old. Frequencies are colored by band as per Setup page 6. Click the org name for a menu to select whether to show bio, max age, desired sort and to edit the Org filter and watch list (see page 20). The Org filter may list multiple orgs separated by spaces to rotate; by + to combine together without rotation; or an empty filter matches all. Click a spot row to set DX, radio (page 14), rotator (page 12) and bio page if used. Spot locations are plotted but paths are not because the spotter location is not available. See page 19 for scrolling.

click org to set whether to show bio (if configured), set max age, set sort and edit Org and watch lists click spot to set DX, radio and show bio if enabled



**DE Wx** and **DX Wx** show the current weather at DE or DX from [OpenWeatherMap.org](http://OpenWeatherMap.org). If the location is not changed for at least an hour, an up or down arrow may appear to indicate the pressure trend direction. When either DE or DX is changed by any means the left pane will temporarily show its weather, unless already selected on another pane or disabled in Setup page 5.

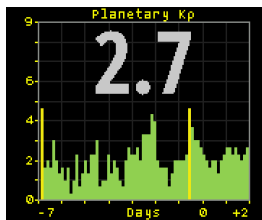

**Planetary K** shows the Kp index now, with a graph extending from 7 days prior to 2 days forecast. The color scheme matches the [NOAA web page](http://NOAA web page).

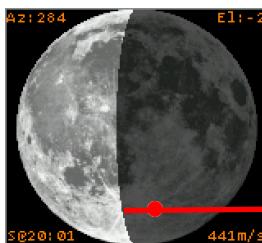

**Moon** displays a graphic of the lunar surface facing earth with the proper portion shown in shadow. The image is oriented depending on the DE hemisphere. The corners show information with respect to an observer located at DE including the Azimuth, Elevation, time of next Rise or Set, and radial velocity where positive values indicate the motion is away from the observer. Click the lower half for a menu to display a full rotation movie or display the EME planning tool (see page 19).

click to show EME planning tool

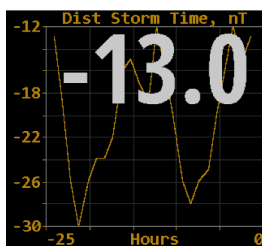

**Disturbance** refers to the Disturbance Storm Time index which measures the onset and recovery of the magnetosphere ring current, in nano Teslas. Values beyond about  $\pm 10$  may indicate sufficient energy is stored in the ring to interfere with lower HF propagation, particularly 160 m. Conversely, values near zero may indicate better than average propagation on this band. Data provided by World Data Center for Geomagnetism, Kyoto University, Japan.

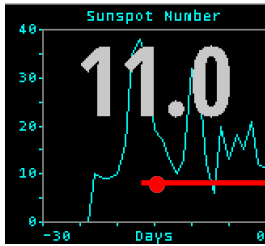

**Sunspot N** shows the current SIDC sunspot number and 30 days history. Since one solar revolution is approximately this period and solar features typically evolve fairly slowly, the graph provides a crude prediction of solar activity for the next month. Click in the lower half to show a longer history.

click to show historical values

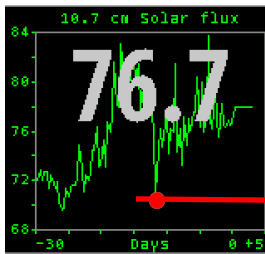

**Solar Flux** shows the current 10.7 cm measurement from National Research Council Canada, as well as a 30 day history and prediction for the next three days. Click in the lower half to show a longer history.

click to show historical values

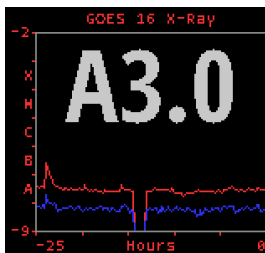

**X-Ray** shows the current solar X-Ray levels and flare classification as measured by the GOES-16 satellite with a 24 hour history. The levels are the powers of a logarithmic scale computed as  $\log_{10}(W m^{-2})$ . The blue line is the 0.05 - 0.4 nm band, red is the 0.1 - 0.8 nm band.

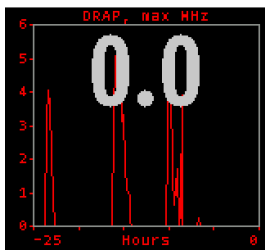

The **DRAP** plot option shows the highest frequency that is attenuated by at least 1 db anywhere on Earth over the past 24 hours. Although the plot does not indicate the location where this occurred, it is usually centered on the Earth daylight side unless there is a Polar Cap Absorption event in progress. Also see the DRAP map option on page 17. The signal paths are for an angle of incidence,  $a$ , of 90 degrees (straight up). For shallower angles, multiply the attenuation by  $1/\sin(a)$ .

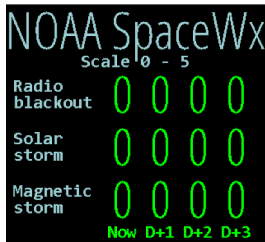

**NOAA SpaceWx** shows the three main NOAA [space weather scales](#). The left column shows the current conditions, and columns to the right are predictions for each of the next three days. All scales use a range of 0 through 5, with larger numbers indicating greater severity and public impact. **Radio blackout** impacts HF communication and navigation; **Solar storm** impacts living organisms and exposed electronics; **Geomagnetic storm** impacts pipeline current, power distribution and disrupts the ionosphere.

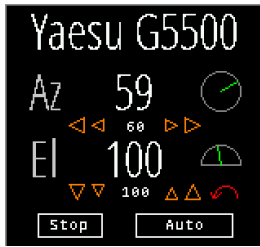

**Rotator control:** If `rotctld` is set in Setup page 3 then a Rotator option is available as a pane choice to control most rotators supported by [hamlib](http://hamlib.org). Set the *host* and *port* fields to the address of rotctld on your network. *You must get rotctld working on your system first, then consider controlling it from HamClock.* The **Az** row shows the rotator azimuth reported by rotctld and an angle graphic. Click the arrows beneath to manually command left and right rotations of 5 and 20 degrees, with the current commanded position shown between in a smaller font. An azimuth beam will also be shown on the main map. If the rotator includes an elevation axis a second row, labeled **El**, provides similar functions.

Clicking **Auto** will either track the current satellite, if one is set and there is an elevation axis, or keep azimuth pointing toward the short path of the current DX location. If the elevation axis can rotate beyond vertical to 180 degrees, *i.e.*, upside down, it will be used to avoid an azimuth wrap during tracking and will be indicated with a red arrow arc on the El row. All motion will cease while the **Stop** button is active or the Rotator pane is not visible. Sat tracking requires HamClock to be set to UTC (see page 19). Pointing direction honors the long or short path setting (see page 12).

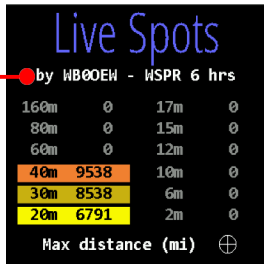

**Live Spots** shows personalized reports from [WSPRnet.org](http://WSPRnet.org), [PSKReporter.info](http://PSKReporter.info) or [Reverse Beacon.net](http://ReverseBeacon.net). With WSPR and PSK you may choose spots posted **by** your own DE **call** or from your **grid**; or spots which others post **of** your DE **call** or **grid**. Using your grid allows

you to explore propagation from your general location without receiving or transmitting. 4-character grid precision is used to find spots near you. Note RBN only works with skimmer spots **of** your call (not **by**) because grids of the spotted transmitter stations are not available. Click the summary line to display a menu that controls these choices as well as maximum age; whether to list count or distance to farthest spot; and which bands to map. Paths show a circle ● at the TX end, a square ■ at the RX end and the farthest path for each band is marked with a target 🎯 and labeled as per Setup page 5. Placing the cursor near either end will show the info table (see page 17).

click for menu

click left half of a row to show map of path reliability for that band

click right half of a row to show map of take-off-angle for that band

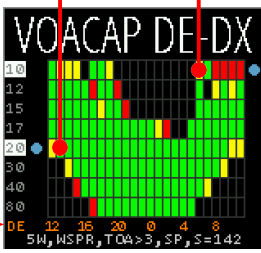

click power, mode, TOA, path

click to show DE or UTC. In the line, ^ indicates current hour.

**VOACAP:** This pane choice shows a graph of path percentage reliability predictions from DE to DX spanning 24 hours for each HF ham band. Graph squares are black if reliability is less than 10%; red if less than 33%; yellow if less than 66% and green if above 66%. Predictions always use VOACAP configured for isotropic 0 dBi antennas on both ends; quiet location noise (-153 db) and the current mean sunspot number. Variable parameters may be set by clicking the fields across the bottom: transmit power, mode, Take-Off-Angle at DE and SP/LP to select Short or Long path. The graph time axis always places now at the left edge. Click the timeline to toggle labels in UTC or DE local time..

Clicking the left half of a band row will show a marker and *add* a world map of path reliability from DE

**Solar wind:** This pane shows 24 hours history of solar wind activity. Solar wind is a good predictor of geomagnetic disturbances such as auroral activity and unusual polar HF propagation. The available real-time metrics are density, in protons  $\text{cm}^{-3}$ , and speed, in  $\text{km s}^{-1}$ . The product of these values gives the flux rate, or number of protons flowing through a unit square per unit time, which is often a better predictor than either value alone. HamClock displays this product in units of  $10^{12}$  protons  $\text{m}^{-2} \text{s}^{-1}$  for which values above five or so suggest better chances for aurora.me..

Clicking the left half of a band row will show a marker and *add* a world map

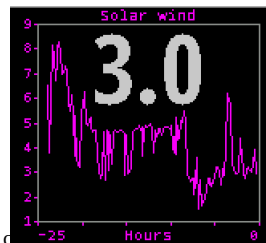



click for menu to set sort, watch list and file name

**\*ADIF:** This pane lists and maps all QSOs in the ADIF file named in Setup page 3. File name is followed by total minus any malformed entries (details are in the diagnostic log, see FAQ 18). Frequencies are colored by band as per Setup page 6. The file is reread every 2 seconds for automatic monitoring. Click file name for menu to set sort and edit watch list (see page 20) or file name. Click a row to assign the DX object. Each ADIF record must define the fields CALL or CONTACTED\_OP; QSO\_DATE; TIME\_ON; BAND or FREQ; and MODE. GRIDSQUARE or LAT and LON are used if present else location is set looking up CALL in cty list. OPERATOR or STATION\_CALLSIGN are used if present else set to DE; MY\_GRIDSQUARE, MY\_LAT and MY\_LON are used if present else set using DE or cty lookup if possible. All other fields are ignored.

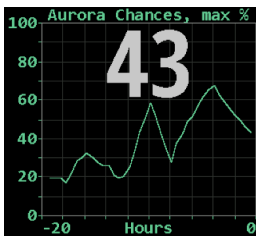

**Aurora** shows the current and recent maximum percent chances of visible activity anywhere on Earth. To see the current best location, change to the Aurora map style (page 17). Active auroral regions can absorb HF but act as reflecting layers at VHF.

\*These choices may be displayed in a taller pane made from combined DE: and DX: panels (see page 7)

## Notes

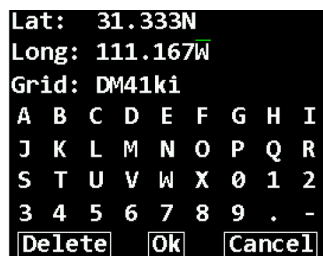

**Setting DE and DX:** Clicking lat, long or grid in the DE: or DX: panes will display a dialog where these values may be directly edited to full precision either by clicking the virtual keyboard or using a real keyboard the same way as Setup. Corresponding values will be computed automatically and invalid entries will be flagged when clicking Ok. Grid coordinates are based on the SW corner.

HamClock always uses full precision internally but, due to limited screen space, rounds the display to whole values. This may lead to unexpected results when entering fractional lat or long values. For example, suppose they are set to 35N and

110.1W so the grid will be DM45ka. The main display will show 35N 110W grid DM45 which, unless one knows the internal values, seems incorrect because 35N 110W exactly is actually in grid DM55. When in doubt, open the dialog to review the values at full precision.

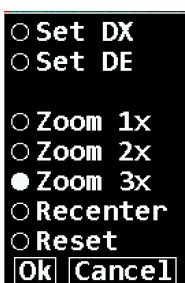

Clicking anywhere on the map brings up a multi-purpose popup menu. It always offers controls to set the HamClock **DE** or **DX** object to the clicked location if desired. It may also offer controls to set a specific **Zoom** factor and/or to **Recenter** the map at the clicked location, depending on the current map projection. The Mercator projection implements all options although recentering may not extend beyond the poles. Robinson can only shift the center longitude, it can not zoom. The other projections can neither zoom nor recenter. The menu starts with the current zoom factor preselected. **Reset** restores the map to full size centered on the longitude specified in Setup page 4. **DX** can also be set immediately without using the menu by either clicking mouse Button 2 (middle) alone, or Button 1 (left) in combination with the Control or meta key (names vary depending on your keyboard).

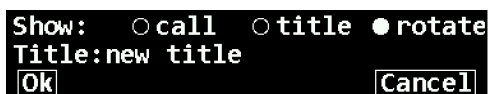

Clicking near the center of the main **call sign box** brings up the menu shown at left. Normally the box shows the DE call sign but it can display any arbitrary text by selecting **title** and entering the desired text here, or rotate between both. Also, if flrig or hamlib's rigctld have been

configured (see Setup page 3) or the GPIO PTT line is used (see page 24), the call box normally displays "On the Air" when the transmitter is keyed (known as PTT or Push-to-Talk) but this can also be changed by entering the desired text here.

**Rig control:** Setup page 3 allows choosing *rigctld* or *flrig* for simple rig control. Set the *host* and *port* fields to the program on your network. When set up correctly, clicking a DX Cluster or On The Air spot will send the frequency to radio VFO A. HamClock also polls PTT to change your call sign to ON THE AIR while transmitting. Three consecutive errors disables PTT polling until the next attempt to send a spot.

You can also monitor PTT using a hardware connection instead of using software rig control, see page 14. Also, the RPi can control the frequency of a KX3 via an IO pin, see page 22 and Setup page 3.

**DX Cluster:** DX cluster control is on Setup page 2. Spider, AR and CC clusters are currently supported. Set **host** to the internet name or IP address of the cluster and **port** to its TCP port number. Filtered and/or watched spots will be listed in the DX Cluster pane as they arrive (see page 9) and displayed on the map according to options on Setup pages 5 and 6. Paths mark the TX end with a circle ● and the RX end with a square ■. If the cursor moves over either end, additional information is shown in the cursor info table (see page 17). Locations are determined using the [AD1C city file](#). Clicking an entry in the list will redefine HamClock's DX to that location and may also tune your radio (see page 14) or command your rotator (see page 12).

- If you make multiple simultaneous connections to the same cluster, be sure they each use a unique login SSID suffix.
-

Toggling **UDP?** to *Yes* on Setup page 2 will instead listen for network UDP packets sent from WSJT-X, N1MM, DXLog, Logger32, Log4OM and possibly other programs on your local network. Set the **port** to match the value used by the program for sending UDP packets. The **host** is only used to match a program sending packets to a multicast address, otherwise it is ignored. Once set up properly, new UDP spots function the same as described above for a DX Cluster.

**Time:** The time shown in large white letters below your call always shows HamClock's idea of UTC. If your DE time is incorrect, click the timezone offset button, see page 19. If the UTC button is black-letters-on-white-background then HamClock is using real UTC. But you may modify the time by clicking on various locations (see page 5). This can be useful, for example, to show a satellite location, gray line or VOACAP prediction at some moment in the past or future. Changing away from UTC causes the UTC button to flash red **OFF** as a stark reminder HamClock is no longer tracking real UTC. Clicking the red button will return abruptly back to real UTC. A large question mark is shown when time is unknown.

- Do not change the large white time to your DE time nor adjust it to correct DE time, use the timezone button.

**Stopwatch:** Click the stopwatch icon (beneath UTC seconds) to enter. Displays elapsed time in HH:MM:SS.SS. Clicking **Run** begins or resumes counting; **Stop** freezes display and counting; **Lap** freezes display but continues counting; **Reset** starts over; click along the spectrum bar to adjust color; **Exit** returns to main HamClock screen.

Independent 24 hour **daily** and **once-only** alarms are available. They may use either DE or UTC time zones. When either is *armed*, the alarm clock icon on the HamClock main screen will be green (instead of gray) and the alarm time may be shown in Big Clock. When either alarm goes off it will be announced on the main screen in the center pane; on the Stopwatch screen by highlighting its control button; and on Big Clock by highlighting the alarm time. Clicking any of these will cancel the alarm; these alerts automatically time out after 60 seconds. See page 22 for hardware control.

**Count down** counts backwards from the value set at its right, click just above or below to increase or decrease down to 1 minute. If counting down is active: the main HamClock screen shows the time remaining in lieu of the stopwatch icon; Countdown may be chosen as a Pane option; and the value may be shown in Big Clock. It may be restarted from any of these locations with a click. Hold the main icon for 3 seconds to enter the Stopwatch screen. See page 22 for hardware control.

**Big Clock** shows a large dedicated clock. Click anywhere for a menu to control options including analog or digital format, UTC or DE, 12 or 24 hour, date info, DE or space weather, seconds, and basic control over alarm and count down.



**Brightness and Light sensor controls:** If a light sensor is installed (aka “photo resistor” for historical reasons) and the *Full scrn direct?* option in Setup page 5 is Yes, then the right-most pane may be set to show two vertical scales. The left shows the current display brightness and the right the current light sensor reading. Both include their respective calibration markers. Brightness is scaled from, and limited to, **Min%** to **Max%** from Setup page 4. If the display can only be turned on or off, the brightness scale will only show a marker at top or bottom. To calibrate a desired brightness response, start by exposing the light sensor to a bright intensity then click in the upper half of the left scale to set the desired display brightness at that intensity (or just “on”). Then expose the sensor to a dim light and click in the lower half to set the desired brightness at that low intensity (or “off”). Systems without a light sensor but with ability to control display brightness will provide a single slider to control display brightness manually.

**On/Off timers:** The upper right-most HamClock pane may provide a table of DE clock **On** and **Off** times at which the display may be set to Max% or Min%, respectively; set the times equal to disable. **Idle** sets the number of minutes of no user activity after which the display may change to Min%; set to zero to disable. Changing the On or Off times will also set the On/Off table in Setup page 7 to match for the current day. Conversely, the pane's values will be reset from this table at each local midnight. If these timers turn the display Off, the light sensor will then **not** control display brightness again until either a timer commands the display back On or the user clicks anywhere in HamClock to restore brightness.

Lat	22N	AF7XZ
Lng	155W	DM42MF
Grid	BL22	W0AY
CQ	31	DN26
ITU	61	WSPR
Pfx	KH6	f 14097.1
LMT	12:10	Age 7m
SP	267°	SNR -25
	2757 mi	SP 346°
Temp	78F	977 mi
Clouds		Temp 53F
		Clouds

**Info table:** A box such as those at left will appear automatically in the upper left corner of the map whenever the cursor is over the map, over a spot on the map or listed in a data pane. The contents depend on context but may contain Latitude; Longitude; Grid; Local Mean Time (does not account for savings time); CQ and ITU zone designations; Prefix; TX and RX call and grid; Mode; Frequency; spot Age; Bearing and Distance from DE; and weather conditions. The bearing degree symbol becomes M if referenced to magnetic north (see Setup page 5). When displaying spot information the border color matches the assigned band color and a red bullseye shows the corresponding map location.

Style:

- Countries
- Terrain
- DRAP
- MUF-VCAP
- MUF-RT
- Aurora
- Weather
- Clouds
- 40m/TOA
- 40m/REL

Grid:

- None
- Tropics
- Lat/Long
- Maidenhead
- Azimuthal
- CQ Zones
- ITU Zones

Projection:

- Mercator
- Azimuthal
- Azim One
- Robinson

- RSS
- Night
- Cities
- Lightning

Ok Cancel

Click the map upper left corner for a menu of viewing options, or ctrl-click to rotate styles:

- **Style** selects the overall map background from the following choices, rotating if multiple are set:
  - political **Countries** and natural **Terrain**
  - **DRAP:** This map style shows a near real-time display of the NOAA *D Region Absorption Predictions* model, or DRAP. The model predicts HF propagation absorption caused by solar X-ray and proton flux events. D layer absorption decreases with increasing frequency, so the map color-codes the highest frequency ray that is attenuated by at least 1 dB while passing through each location. Rays at lower frequencies will experience progressively greater attenuation of 30 dB or more. The color scale is gray for no absorption at any frequency progressing through a spectrum to indicate higher frequencies. See also the DRAP pane (page 17) for a time history.
  - **MUF-VCAP:** This map style shows the VOACAP model for median Maximum Usable Frequency between DE and other points in the world about half the time each month. This model is useful for long term planning, such as for a DXpedition; the MUF-RT style is a better indication of current conditions. Note even when a path seems promising, it may still not be unusable due to low signal power, local noise or variable space weather conditions. The map is color coded the same as DRAP.
  - **MUF-RT:** This style shows a real-time map of Maximum Usable Frequency based on a worldwide consortium of ionosondes, those of which were active within in the last hour are labeled with their reporting frequency. The data are updated every fifteen minutes. Note that since the stations are not spaced uniformly, significant license was required to perform global interpolation. At any given location, the MUF value is the highest frequency that will refract back

to Earth a wave launched 1500 miles away, thereby supporting a total single hop path of 3000 miles. Waves higher in frequency will generally continue on to space and be lost. Using this basic model, one can imagine where the hops will occur along a path from DE to DX and estimate whether they will be supported for a given band. Note even when a path seems promising, it may still not be unusable due to low signal power or local noise. This map is a good indication of current conditions; the MUF-VOACAP style is better suited for long term planning such as for a DXpedition. Both use the same color key. Data for this map are from [GIRO](#) collected and used by permission from [KC2G](#).

- **Aurora:** This map style shows the chances for aurora activity based on total ionospheric energy deposition. High activity is often associated with geomagnetic storm conditions. This map is best viewed with the Azimuthal projection.
- **Weather:** shows color-coded temperature, pressure isobars and wind speed direction flags; updated hourly.
- **Clouds:** shows global IR reflectance satellite imagery delayed by 1-2 hours.
- **/TOA or /REL :** when selected in band conditions (see page 12) for the selected band, selects take off angle or reliability map style
- **Grid overlay:**
  - **Tropics** draws global lines at  $\pm 23.5$  degrees latitude
  - **Lat/Long** draws lines of constant latitude and longitude every 15 degrees
  - **Maidenhead** draws (and labels in Mercator projection) each top-level grid square
  - **Azimuthal** draws radial lines every 15 degrees of bearing and rings at constant distance from DE
  - **CQ or ITU zones** draws the boundaries of these global regions
- **Map Projection:**
  - **Mercator** is the classic form with equally spaced lines of latitude and longitude; large distortion near poles.

- ***Azimuthal*** shows front and back hemisphere views centered on DE and its antipode, respectively.
- ***Azim One*** is one full globe centered on DE; the entire outer edge is the single antipode point.
- ***Robinson*** is the popular projection often used in publishing; pleasing but has distortion everywhere.
- **RSS**: overlays the lower map with live RSS feeds, cycling every 15 seconds. Click to show parent web page.
- **Night**: select to darken the map where it is currently night time; good for showing current gray line boundary.
- **Cities**: whether to display name and population of representative cities nearest to cursor, if any.
- **Lightning**: select to display lightning icons that indicate detected lightning. Range rings for the coverage area are shown.

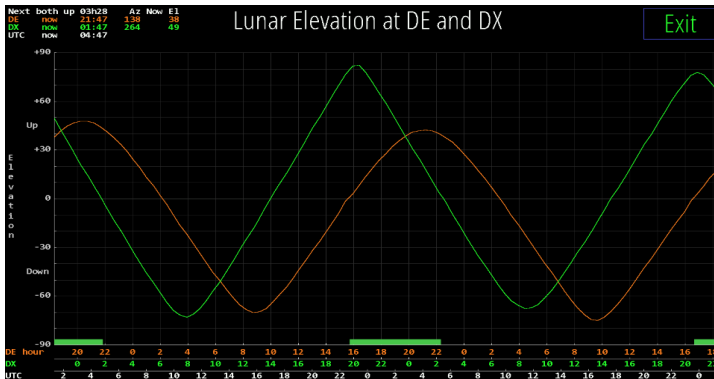

The **EME planning tool** is shown by clicking in the lower half of the Moon pane (see page 10). The tool plots the lunar elevation at DE and DX for the next two days starting now. The time axis is labeled in DE and DX local time and UTC. The current time is always at the left end. The table in upper left shows the next period when the moon is simultaneously up at both DE and DX and the current Az and El at each location. All such periods are also marked along the time line. Click the plot anywhere for detailed information at that moment. Click Exit to restore normal HamClock operation.

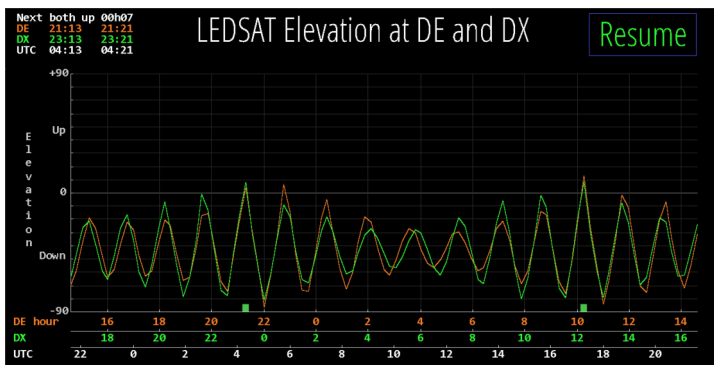

The **Satellite planning tool** is shown by selecting it from the DX pane when it is showing satellite info (page 9). The tool plots the elevation at DE and DX for the next day starting now. The time axis is labeled in DE and DX local time and UTC. The table in upper left shows the next period when the satellite is simultaneously up at both DE and DX. All such periods are also marked along the time line. Click the plot anywhere for detailed information at that moment. Click Resume to restore normal HamClock operation or let it time out.



**Scroll controls** appear automatically when panes have too many lines to display. *Up* shows how many more lines are above, *Down* shows the number below. Clicking either shifts the list in the given direction, leaving one line for

context. Setup page 5 allows setting whether the list grows top-down or bottom-up. If the scroll entries are DX spots, the arrow is red if there are any spots in that direction matching a Red watch list (see page 20). If new spots arrive while scrolled away from the front of the list, the list position does not change but a button labeled **New** appears; clicking it will jump immediately to the front of the list. Also while scrolled away the border is red, pane rotation is suspended and clicking the title does *not* offer a menu to assign new choices.



Click the **Time zone** control for DE or DX to set a manual offset or automatic. Automatic sets the UTC offset and adjusts for Daylight Savings Time based on approximate location; set an offset manually if incorrect. The setting will persist across restarts but changing a location always resets to automatic. Note the correction for DST may not engage until an hour or so after the official change.



**Demo mode:** Click the padlock to select this mode which means HamClock will autonomously make a random setting change to itself every 30 seconds, including the plot panes, DX location and map view options. The running man icon indicates demo mode is active. Meanwhile HamClock may still be used normally. Note that whether Demo mode is active is *not persistent*, so it must be selected again if desired each time HamClock starts.

**Watch lists** are used to filter DX Cluster, On The Air and ADIF spots. They may be edited either in the Setup session or within the popup menus for each pane. Each watch list consists of one or more *specifications* separated by commas. Each specification may consist of any of the following *requirements*, all of which are optional:

- **band names** in several formats:
  - a single band name followed by *M* for meters, such as 40M
  - multiple bands separated by hyphen in either order, such as 20-10M or 10-20M
  - a sub-band mode may be specified following the band number such as 40CW or 20SSB or 30FT8
  - multiple sub-band ranges separated with a hyphen, such as 160-10CW or 10-20DATA
- **exact frequency range:**
  - min-max in MHz which may span multiple bands, such as 14-14.02MHZ or 7.0-10.15MHZ
- **ADIF keyword:** predefined qualities of a spot which must *not* be found within the current ADIF file:
  - **NADXCC:** no ADIF entry matches the spot's DXCC entity
  - **NAPREF:** no ADIF entry matches the spot's prefix
  - **NAGRID:** no ADIF entry matches the spot's grid (first 4 characters only)
  - **NABAND:** no ADIF entry matches the spot's band
  - these may be combined, such as NAGRID NABAND to require no matching grid square or band
- **prefix:** anything not fitting the above rules specifies the required leading characters of a call (see more below)

Notes:

- Prefixes only check their number of characters for a match. Ex: prefix AA matches AA0 and AA1 but not A or AB.
- Spot call signs containing a slash (/) are broken into "dx" and "home" portions. The "dx" portion is the shorter side but is *ignored* if it consists of 1 character or digit, is one of the abbreviations /MM or /AM, or consists of 3 or more characters without any digits such as /QRP. Calls without a slash are always considered to be "home" calls. Ex: VK2/WB0OEW and WB0OEW/VK2 both assign "dx" to VK2 and "home" to WB0OEW, but WB0OEW/0 assigns "home" to WB0OEW but has no "dx" portion because /0 is ignored.
- Watch list prefixes that end in a slash, /, apply only to the "dx" portion of a portable call. Prefixes without a slash apply only to the "home" portion of a call. Ex: the prefix VK2 **will** match WB0/VK2ABC but **not** VK2/WB0OEW; conversely prefix WB/ **will** match VK2ABC/WB0 but **not** WB0OEW/VK2.
- A spot is considered a match if it is selected by **all** the given requirements within **any** of the given specifications.
- Think carefully when mixing watch lists with native DX Cluster commands (see Setup page 2).
- The ADIF keywords may not be used in the ADIF watch list.
- The supported sub-band modes are based on those in DX clusters: CW, DATA, FT4, FT8, RTTY, SSB. **Modes are implemented as frequency boundaries, not actual transmission content, so may not be correct.**

Each watch list can be set to control its display list in one of four ways:

- Off:** HamClock will save the watch list but it has no effect; all spots are displayed normally.
- Red:** all spots are displayed but those which match are highlighted in red in the display list.
- Only:** like Red but only the matching spots are displayed.
- Not:** the opposite of Only, *i.e.*, only spots that do **not** match all specifications are displayed.

Example Watch List	A spot matches if ...
30M	... it is any frequency on 30 meters
40-80M	... it is any frequency on 40 or 80 meters
20-10DATA	... it is any frequency spiders consider DATA on 20 through 10 meters
20m WA WB K	... it is on 20 meters with home prefix WA or WB or K
7.0-7.01MHZ	... it is in the DX CW window of 40 meters
VK/ 20M 30M, ZL/ 30M	... it is a portable station in VK on 20 or 30, or a portable ZL station on 30
NADXCC	... its DXCC does not match any spot in the ADIF file on any band. <i>use this to look for new DXCC entities.</i>
NADXCC NABAND	... both its DXCC and band do not match any one spot in the ADIF file. <i>use this to look for new band slots.</i>
40M NAPREF	... it is on 40 and has a prefix not in the ADIF file. <i>use this to look for new prefixes on 40m</i>

20-10M NAGRID	... it is on any band from 20 to 10 and no spots in the ADIF file have the same grid. <i>use this to look for new grids on these bands.</i>
---------------	--

## External IO Options

HamClock supports several optional external devices to enhance the operator experience. These include

- one or two BME280 environmental sensors for temperature, pressure and humidity;
- LTR329 light sensor for automatic dimming depending on ambient lighting (see page 16);
- several switches and LEDs to complement the ON THE AIR indicator, timer, alarm clock and satellite status;
- time and location from NMEA sentences from the serial connection of a GPS receiver;
- Elecraft KX3 serial frequency control, available only with RPi header pin 8.

These devices may be connected to HamClock in two different configurations, as shown below. Devices may be connected in any order and all are optional.

- to the 40 pin header of a Raspberry Pi
- to any linux or Mac with a USB port using an I2CMini from [i2cdriver.com](http://i2cdriver.com), including the Pi if preferred

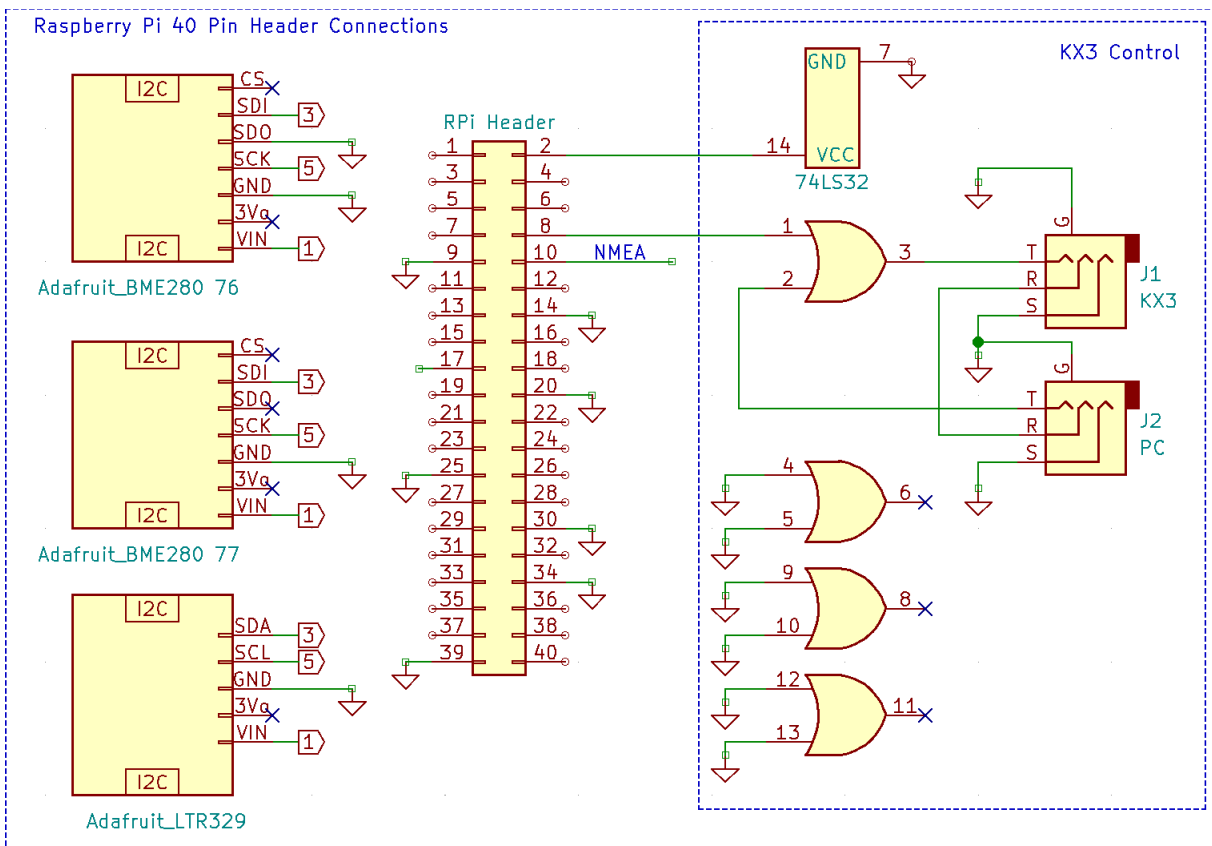

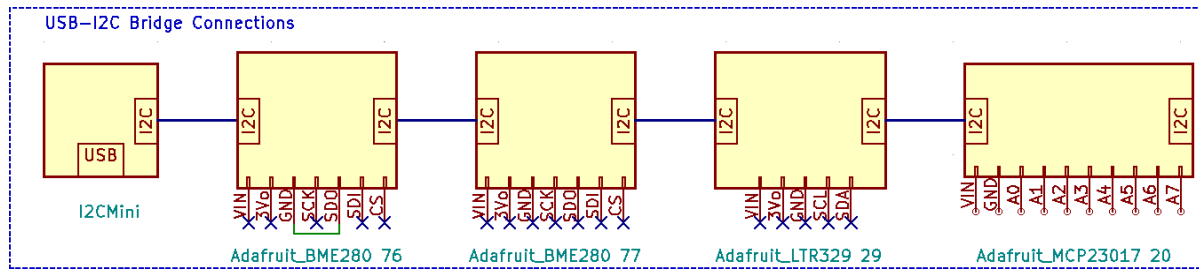

The discrete GPIO options are described in the table below. Each is independent and may be chosen separately as desired. Connect the Terminal connections to either the Pi header or the MCP23017 port expander, depending on the HamClock configuration used on page 22. The MCP23017 is not needed if none of these are used.

On a Raspberry Pi, Setup page 4 also includes a toggle named **GPIO**. Setting this Off prevents HamClock from using any of the native pins in order that they may be used for something else. To use the I2C header pins on a RPi the **GPIO** toggle must be set to Active *in addition to* setting the proper file name (see next).

GPIO Option	Description	Terminal	Pi Header Pin	MCP23017 Pin
	A falling edge from a SPST switch or PTT line on terminal CD_4 (re)starts the count down timer. Driving voltage, if any, must not exceed 3.3 V. The LEDs indicate the time remaining: green when counting down; both when 1 minute or less remains; red when timed out.	CD_1 CD_2 CD_3 CD_4	17 33 35 37	VIN A0 A1 A2
	Output terminal SA_A indicates satellite visibility from DE. Normally low, it cycles high at 1 Hz for 1 minute before rise, stays high during the pass, cycles at 2 Hz during the last minute then stays low again after set.	SA_1	38	A5
	Grounding input terminal OA_1 with a switch or PTT line will change the call sign text to "ON THE AIR". Driving voltage, if any, must not exceed 3.3 V.	OA_1	40	A6
	Output terminal AL_1 will go high while either alarm is "ringing". The schematic shows an LED but a piezo buzzer works also. Briefly grounding input terminal AL_2 will silence either alarm.	AL_1 AL_2	31 29	A3 A4

This flexibility does come at a price. You must determine and enter the name assigned by the host to the native or bridged I2C bus in the **I2C file** field of Setup page 4. The table below shows a sample of systems and *typical* names. One way to discover the *exact* name on linux is to start a terminal session and run the command `ls /dev`. Look for something similar or, in the case of a USB-I2C bridge, remove and plug the device back in and see what changes. If you find both **tty** and **cu** names that are otherwise the same, always use the cu name.

Configuration	Typical I2C File name
Raspberry Pi 40 pin header	Debian /dev/i2c-1 FreeBSD /dev/iic0
USB-I2C bridge	Debian /dev/ttyUSB0 FreeBSD /dev/cuaU0 macOS /dev/cu.usbserial-DK0C3XGZ

The serial output from a GPS module that sends the RMC NMEA sentence may be connected directly to HamClock. The TX line from the module can be connected to Raspberry Pi header pin 10 or via any serial-USB converter cable supported by your computer operating system.

- To use the RPi header, perform the following steps:
  - connect the TX line from the module to header pin 10. If needed, +5V can be taken from pin 2 and ground from pin 14.
  - run **sudo raspi-config**, go to Interfaces and select Serial. Turn Off console and On hardware support; finish and reboot
  - Got to HamClock Setup page 1, turn on NMEA, set the baud rate of the GPS module and enter file **/dev/serial0** on RPi 4 or earlier, or **/dev/ttyAMA0** on RPi 5.
- To use a USB converter cable on any computer running HamClock:
  - connect cable +5V, ground and RX to the GPS module and plug the USB end into the computer.
  - run **ls /dev** before and after plugging in the USB to find the new entry. On RPi it might be **/dev/ttyUSB0**; macOS something like **/dev/cu.usbserial-AL00FP5D**; FreeBSD it might be **/dev/cuaU0**.
  - Go to HamClock Setup page 1, turn on NMEA, set the module baud rate and the file name found above.
- Bonus! Use a UNIX fifo:
  - Use **mkfifo** to create a fifo file anywhere
  - Enter the fifo path as the HamClock NMEA file. Baud rate does not matter.
  - Now any NMEA sentences piped into the fifo will be read and processed by HamClock.

## Command Line Options

The hamclock program accepts the following optional arguments. For example: to skip the initial setup screens (assuming all fields are valid) to immediately begin normal operation, change the read/write web interface to port 20000, and throttle the CPU load to 20%, run hamclock as:

```
hamclock -k -w 20000 -t 20
```

```
-0 : restore all original default Setup values
-a x : set debug name=level, bogus name gives list
-b h : set backend host:port to h; default is clearskyinstitute.com:80
-d d : set working directory to d; default is ~/.hamclock/
-e p : set RESTful web server port to p or -1 to disable; default is 8080
-f o : force display full screen initially to "on" or "off"
-g : init DE using geolocation with current public IP; requires -k
-h : print this help summary then exit
-i i : init DE using geolocation with IP i; requires -k
-k : start in normal mode, ie, don't offer Setup or wait for Skips
-l l : set Mercator or Robinson center longitude to l degrees, +E; requires -k
-m : enable demo mode
-n t : set live web idle timeout to t minutes; default forever
-o : write diagnostic log to stdout instead of in ~/.hamclock/
-p f : require passwords in file f formatted as lines of "category password"
      changeUTC configurations exit newde newdx reboot restart setup shutdown unlock upgrade
-q : ignore saved startup screen location and size
-r p : set read-only live web server port to p or -1 to disable; default 8082
-s d : start time as if UTC now is d formatted as YYYY-MM-DDTHH:MM:SS
-S s ; set Software server host for OTA download; default is clearskyinstitute.com
      Must come after -b if used
-t p : throttle max cpu to p percent; default is 80
-T t ; set max timeout for responses from backend; default is 10
-v : show version info then exit
-w p : set read-write live web server port to p or -1 to disable; default 8081
-x n : set n max live web connections; max 100; default 10
-y : activate keyboard cursor control arrows/hjkl/Return -- beware stuck keys!
```

## RESTful webserver command reference

In addition to the Hamclock's main web interface HamClock provides a REST interface that allows external control by the user via a browser or programmatically by an external program. The general web interface is, by default, on port 8081 (See options `-w` and `-r` on page 26), HamClock's REST interface is, by default, on port 8080 (See option `-e` on page 26).

The REST (Representational State Transfer) interface takes a command in the form of a web address with an argument that return result information in ascii text form. Please note that some web browsers may not access these rest web addresses consistently so command line access is recommended using command `curl` which is available on Windows and Linux. An exception is `antennas.html` which is a widget designed to work in a browser.

Commands that take arguments have the argument start with `?` and any additional arguments separated by `&`. Here is an example of setting the grid to EM13 and the callsign to KR8X:

```
curl "http://172.18.51.41:8105/set_newde?grid=EM13&call=kr8x"
```

Entering an invalid command or no REST command after the RESTful port will list all of the available RESTful webserver commands (for example): `curl "http://192.168.1.42:8080/"`

<code>antennas.html</code>	antennas widget to administer antenna information
<code>get_antennas.txt</code>	Get antenna information from hamclock and backend
<code>get_capture.bmp</code>	get live screen shot in bmp format
<code>get_config.txt</code>	get current display settings
<code>get_contests.txt</code>	get current list of contests
<code>get_de.txt</code>	get DE info
<code>get_dx.txt</code>	get DX info
<code>get_dxpeds.txt</code>	get current list of DXpeditions
<code>get_dxspots.txt</code>	get DX spots
<code>get_gpio?</code>	pin=MCP&latched=[true,false]
<code>get_livespots.txt</code>	get live spots list
<code>get_livestats.txt</code>	get live spots statistics
<code>get_ontheair.txt</code>	get POTA/SOTA activators
<code>get_satellite.txt</code>	get current sat info
<code>get_satellites.txt</code>	get list of all sats
<code>get_sensors.txt</code>	get sensor data
<code>get_spacewx.txt</code>	get space weather info
<code>get_sys.txt</code>	get system stats
<code>get_time.txt</code>	get current time
<code>get_voacap.txt</code>	get current band conditions matrix
<code>list_antennas.txt</code>	list antenna indexes and description
<code>set_adif?</code>	pane=[0123] (POST)
<code>set_alarm?</code>	state=off armed&time=HR:MN&utc=yes no
<code>set_antennas?</code>	
<code>antdeindex=n&amp;antdxindex=n&amp;antdedxcontrol=n&amp;antdeaz=n.n&amp;antdxaz=n.n</code>	
<code>set_auxtime?</code>	format=[one_from_menu]
<code>set_bmp?</code>	pane=[1,2,3,map]&fit=[resize,crop,fill][&off] (POST)
<code>set_cluster?</code>	host=xxx&port=yyy
<code>set_debug?</code>	name=xxx&level=n
<code>set_defmt?</code>	fnt=[one_from_menu]&atin=RSAtAt RSInAgo
<code>set_displayOnOff?</code>	on off
<code>set_displayTimes?</code>	on=HR:MN&off=HR:MN&day=[Sun..Sat]&idle=mins
<code>set_gpio?</code>	pin=MCP&level=[hi,lo]&blink=hz
<code>set_livespots?</code>	(see error message)
<code>set_mapcenter?</code>	lng=X
<code>set_mapcolor?</code>	setup=name&color=R,G,B
<code>set_mapview?</code>	Style=S&Grid=G&Projection=P&RSS=on off&Night=on off
<code>set_newde?</code>	grid=AB12&lat=X&lng=Y&call=AA0XYZ
<code>set_newdx?</code>	grid=AB12&lat=X&lng=Y

```
set_once_alarm?      state=off|armed&time=YYYY-MM-DDTHR:MN&tz=DE|UTC
set_pane?            Pane[0123]=X,Y,Z... any from:
                    VOACAP_DEDX DE_Wx DX_Wx Solar_Flux Planetary_K Moon NOAA_SpcWx Sunspot_N
                    X-Ray SDO Solar_Wind DRAP Contests Live_Spots Bz_Bt On_The_Air Aurora
                    DXpeditions Disturbance
set_panzoom?        pan_x=X&pan_y=Y&pan_dx=dX&pan_dy=dY&zoom=Z
set_rotator?        state=[un]stop|[un]auto&az=X&el=X
set_rss?            reset|add=X|network|interval=secs|on|off|file (POST)
set_satname?        abc|none
set_sattle?         name=abc&t1=line1&t2=line2
set_screenlock?     lock=on|off
set_senscorr?       sensor=76|77&dTemp=X&dPres=Y
set_stopwatch?     reset|run|stop|lap|countdown=mins
set_time?           change=delta_seconds
set_time?           ISO=YYYY-MM-DDTHH:MM:SS
set_time?           Now
set_time?           unix=secs_since_1970
set_title?          call|title|onair=[text]&fg=R,G,B&bg=R,G,B|rainbow
set_touch?          x=X&y=Y
set_voacap?         band=X&power=W&tz=DE|UTC&mode=X&map=X&TOA=X
exit                exit HamClock
postDiags           post diagnostic logs and configuration settings
restart             restart HamClock
updateVersion       update to latest version
```

## Directional Antenna Maps

Band conditions, Reliability Maps, Take Off Angle Maps and Voacap Maps default to a generic omnidirectional isotropic antenna for the DE location and DX location. RESTful commands are available to administer the types of antennas and how they are used (see page 27). Directional antenna support requires support of the backend server.

Restful command antennas.html brings up the Antenna manager widget for user control of this function.

### Antenna manager

Controls HamClock antenna selection - DE, DX index and DE/DX control mode

73 antennas loaded — DE: 258 (HR 4/4/.8), DX: 1056 (VM/.25 :Sample type 32 ITS-78 Vertical Monopole), control: 3

DE/DX ANTENNA CONTROL MODE

antdedxcontrol

Controls which antenna index is sent to the backend

DE ANTENNA 258 - HR 4/4/.8

Antenna (antdeindex)  Az (antdeaz) deg

DX ANTENNA 1056 - VM/.25 :SAMPLE TYPE 32 ITS-78 VERTICAL MONOPOLE

Antenna (antdxindex)  Az (antdxaz) deg

## Version History

### Version 4.24: May 2026

- fix: maidenhead conversions in REST api
- add: show lightning strikes on maps
- add: directional antennas in voacap
- add: highlight "now" as ^ in VOACAP DE-DX

### Version 4.23: April 2026

- fix: 1-sat crash in Show planner
- change: better diag file posting
- change: show backend host/IP in status
- fix: prevent OTA crash on long pre/suffix
- fix: gpio pin for alarm
- add: add -T for HTTP timeout
- add: add T= build argument for HTTP timeout
- add: add -S for alt software server
- add: add S= build argument for software server
- add: add B= build argument for backend server:port

### Version 4.22: 2026-01-17

- change: clicking wifi strength now shows a history plot
- fix: don't offer Moon track in satellite menu
- fix: make satellite track option persistent
- fix: satellite name could overlay RSS
- fix: remove unused watchdog function calls
- fix hopefully: TZ updates could repeat continuously if net fails

### Version 4.21: 2025-09-06

- new: support up to two simultaneous satellites
- new: add Live Spots menu item to choose whether to show paths
- change: add next rise and set azimuth to Sat pane
- change: tweak satellite path arrowheads
- fix: TZ updates could repeat continuously if net fails even briefly

### Version 4.20: 2025-07-06

- fix: NOAA SpaceWx day label color was not consistent
- fix: add arrows to dashed satellite path
- fix: Big Clock refresh could leave extra bits
- fix: avoid versions of gpiod that are too old

### Version 4.19: 2025-06-10

- change: add timeline labels beneath NOAA SpaceWx columns
- fix: next sat pass was not updated after set

### Version 4.18: 2025-06-07

- new: support user file of sat TLEs in ~/.hamclock/user-esats.txt
- new: add Setup option to configure desired max sat TLE age
- new: add Setup option to set minimum spot label distance
- new: ctrl-click data pane title, map style or NCDXF to force rotation
- change: EME tool is now full size and remains up until dismissed
- change: separate Demo and padlock icons
- change: + in On-The-Air Org shows all selections without rotation
- change: NOAA SpaceWx pane now spells out scale and category

meanings change: show expedition mode if spotted

change: add satellite TLE age above passfix: map info table lookup is now faster to handle larger data sets fix: add Makefile

args FB\_DEPTH=16/32 and WIFI\_NEVER=0/1 fix: posting diagnostics worked but menu was broken

## Credits

HamClock would not be possible without the following resources:

Space Weather Prediction Center for several data sets: Sunspot number  
Solar flux monthly and current Aurora  
Scales DRAP X-Ray Solar wind  
K index and K and SFI forecast Bz and Bt

Jari Perkimki, Gregory Hand and Jim Watson for generous VOACAP support. DX cluster operators and spotters the world over.

SOTA, POTA and WWFF users and their respective data base maintainers.

Bruce Horn, WA7BNM, for the 8 day context calendar.

Celestrak for timely satellite elements. NASA for SDO and

STEREO images.

National Research Council Canada for 70 years of continuous 10.7 cm solar flux data.

Open Weather Map for near-real-time world-wide weather data.

Philip Gladstone, N1DQ, for assistance and live data from his web site PSKReport.info .

Pete Smith, N4ZR, and Felipe Ceglia, PY1NB, for the Reverse Beacon Network.

Arne for assistance and live data from his site wspr.live.

NOAA for the World Magnetic Model and their Science on a Sphere real-time cloud maps. Davidson Francis for his Websocket server.

Andrew D. Rodland, KC2G, for his ionosonde data via GIRO.

Sean Barrett for a compact and easy-to-use image format writer. Jim Reisert, AD1C, for maintaining the cty country file.

ITU and CQ zones based on data from zone-check.eu.

Mario, DL4MFM, for his support and assistance with data from WWFF. DX expedition data from NG3K and DXNews

World Data Center for Geomagnetism, Kyoto University, for DST data

And special shoutouts to Adafruit and Raspberry Pi Foundation for great products and support.